

**Define**<sup>®</sup>  
Innovative Insights - Inspire



**Define**<sup>®</sup>  
Innovative Insights - Inspire

**DEFINE OVERSEAS PVT. LTD.**

Regd. No: 390 004

Chennai, INDIA

Tel: +91 97277 8048

E-Mail: [info@definehardware.in](mailto:info@definehardware.in)

[www.definehardware.in](http://www.definehardware.in)

Define Hardware



Follow Us



## GLASS RAILING SYSTEM

[www.definehardware.in](http://www.definehardware.in)



#### **OUR MISSION:**

Our mission is to grow the quality product along with the best customer service with product guarantee. We are committed to provide satisfaction to each customer. Customer we serve.

#### **OUR WAY OF WORK:**

Innovation goes way to innovation - followed with studies, we focus on through research and development products. While designing the products, we meet the needs of regular activities and create designs for excellent quality, convenience and safety purposes.

#### **SUPERIOR QUALITY WITH GREATER CONSISTENCY:**

Exceeding expectations in engineering and research. We define always beyond the limits of the complex design. Whether it is about designing our products or its mass building with consistent, no errors in repeating the operations. Established in 2010, based in Maharashtra and the world's rapidly growing industrial areas of Western India. With cutting-edge facilities and our dedicated efforts and circumvent expertise, we have earned a name as the leading manufacturer of glass railings and related products. We supply products in all of the global products, characterized by superior quality and service to the market.

#### **METHODOLOGY:**

We can help users that the business activities and product market to full of competitors and why way to stand out competitors to ensure superior quality of the most competitive price. We give maximum importance to the utilization of our material and process highest level of quality control with total work force resources only. We have set up a state-of-the-art manufacturing facility, to support the operation and convert the designs into finished products. Super quality solutions with speed technology to provide us to create along with our the customer, going beyond to the limit and beyond.

Investment to build long term relationship with our customers and clients and provide exceptional customer services by providing business through innovation and advanced technology.

We provide quality products that exceeds the expectations of our customers and give to build long term relationship with our customers and clients and provide exceptional customer services by providing business through innovation and advanced technology. We endeavor to the forefront of the industry by providing advanced services, reliable products and quality.

# Index

PAGE  
**05**



**Bracket With  
Continuous Cover System**

PAGE  
**39**



**Side Mount  
System**

**Continuous  
System**



PAGE  
**13**

**Bracket  
System**



PAGE  
**43**

PAGE  
**33**



**Concealed  
System**

PAGE  
**55**



**Tops Handrail  
System**

**Bracket With  
Continuous Cover System**



*Quality*  
Isn't a Demonstration  
It is a Propensity.

**Finishes**

Wooden | Anodized | Powder Coating

**Specification**

- 1) System For 12 mm Glass
- 2) Support Glass Height Up to 3 Feet
- 3) Bracket Size: 70mm & 140mm
- 4) Cover Length: 16 Feet & 32 Feet Or Customized



**DF-8K3-01**

**STEP**



Slotted Covering



Full Covering

Find The *Best*  
Solutions With Us.

**Finishes**

Wooden | Anodized | Powder Coating

**Specification**

- 1) System For 12 mm Glass
- 2) Support Glass Height Up to 3 Feet
- 3) Bracket Size: 70mm & 140mm
- 4) Cover Length: 16 Feet & 32 Feet Or Customized



**DF-8K3-02**

**HEAVY 140MM**

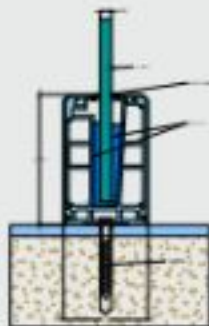

Slotted Covering



Full Covering

Profits are the outcome,  
the *Result* of  
incredible administration.

**Finishes**

Wooden | Anodized | Powder Coating

**Specification**

- 1) System For 12 mm Glass
- 2) Support Glass Height Up to 3.5 Feet
- 3) Bracket Size: 70mm & 140mm
- 4) Cover Length: 16 Feet & 32 Feet Or Customized



**DF-BK1-03**  
**HEAVY 132MM**



Slotted Endcap



Full Endcap

Measure what is  
quantifiable and *Make*  
quantifiable what isn't.

**Finishes**

Wooden | Anodized | Powder Coating

**Specification**

- 1) System For 12 mm Glass
- 2) Support Glass Height Up to 2.5 Feet
- 3) Bracket Size: 70mm & 140mm
- 4) Cover Length: 16 Feet & 32 Feet Or Customized



**DF-BK1-04**  
**SLK E**

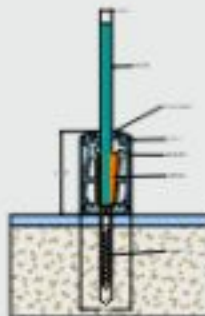

Slotted Endcap



Full Endcap

Extraordinary service,  
*Extraordinary* you.

**Finishes**

Wooden | Anodized | Powder Coating

**Specification**

- 1) System For 12 mm Glass
- 2) Support Glass Height Up to 3 Feet
- 3) Bracket Size: 70mm & 140mm
- 4) Cover Length: 16 Feet & 32 Feet Or Customized



**DF-BK-05**  
**STEP**

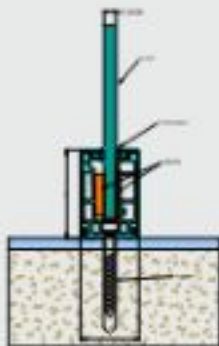

Slotted Envelope



Full Envelope

Our buyers are our  
*utmost Responsibility*

**Finishes**

Wooden | Anodized | Powder Coating

**Specification**

- 1) System For 12 mm Glass
- 2) Support Glass Height Up to 3 Feet
- 3) Bracket Size: 70mm & 140mm
- 4) Cover Length: 16 Feet & 32 Feet Or Customized



**DF-BK-06**  
**HEAVY 142MM**

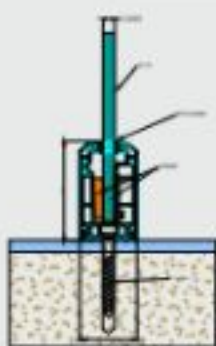

Slotted Envelope



Full Envelope

## Continuos System





Assistance is an unseen sign of *Genright*

**Finishes**

Wooden | Anodized | Powder Coating

**Specification**

- 1) System For 12 mm Glass
- 2) Support Glass Height Up to 3 Feet
- 3) Cover Length: 16 Foot & 32 Foot Or Customise



**DF-CP-01**

**FERRY**

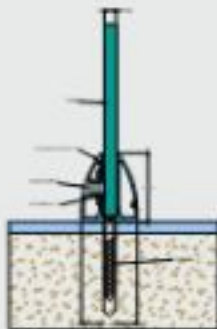

Optional Curved Cover



Flat Cover

We have techniques for assisting *Perfally*

**Finishes**

Wooden | Anodized | Powder Coating

**Specification**

- 1) System For 12 mm Glass
- 2) Support Glass Height Up to 3 Feet
- 3) Cover Length: 16 Foot & 32 Foot Or Customise



**DF-CP-02**

**NEW FERRY**



Flat Cover

Best assistance, perfect time,  
*Perfect People.*

**Finishes**

Wooden | Anodized | Powder Coating

**Specification**

- 1) System For 12 mm Glass
- 2) Support Glass Height Up to 3 Feet
- 3) Cover Length: 16 Foot & 32 Foot Or Customise

DI-CP-03

60MM FLAT

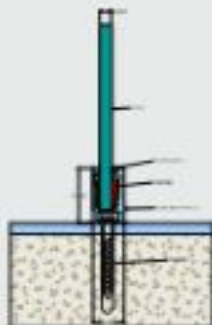

Slanted Endcap



Full Endcap



Everyone promises good  
services but *He* one really serves

**Finishes**

Wooden | Anodized | Powder Coating

**Specification**

- 1) System For 12 mm Glass
- 2) Support Glass Height Up to 3 Feet
- 3) Cover Length: 16 Foot & 32 Foot Or Customise

DI-CP-04

60MM CURVED



Slanted Endcap



Full Endcap



Everyone works for quantity,  
we work for *Quality*

#### Finishes

Woods | Anodized | Powder Coating

#### Specification

- 1) System For 12 mm Glass
- 2) Support Glass Height Up to 3 Feet
- 3) Cover Length: 16 Foot & 32 Foot Or Customise



D-CF-05

60X3MM FLAT

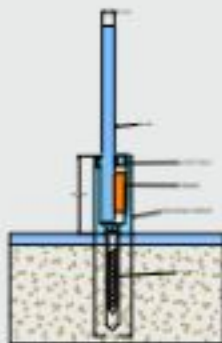

Full Enclage

There are no substitutes  
for hard work

#### Finishes

Woods | Anodized | Powder Coating

#### Specification

- 1) System For 12 mm Glass
- 2) Support Glass Height Up to 3 Feet
- 3) Cover Length: 16 Foot & 32 Foot Or Customise



D-CF-06

60X3MM CURVED

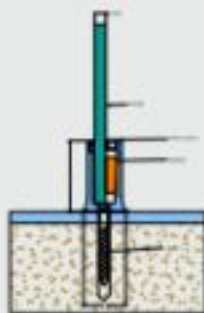

Full Enclage

Small experiments lead  
to big *Innovations*

#### Finishes

Wooden | Anodized | Powder Coating

#### Specification

- 1) System For 12 mm Glass
- 2) Support Glass Height Up to 3.5 Feet
- 3) Cover Length: 16 Foot & 32 Foot Or Customise

DI-CP-07

100X5/MM



Full Endcap



We listen to what  
customers *Want*

#### Finishes

Wooden | Anodized | Powder Coating

#### Specification

- 1) System For 12 mm Glass
- 2) Support Glass Height Up to 3.5 Feet
- 3) Cover Length: 16 Foot & 32 Foot Or Customise

DI-CP-08

120X5/MM

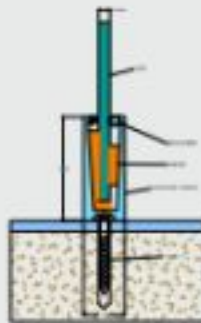

Full Endcap



*Service* is the best gift  
of attention

#### Finishes

Wooden | Anodized | Powder Coating

#### Specification

- 1) System For 12 mm Glass
- 2) Support Glass Height Up to 3 Feet
- 3) Cover Length: 16 Feet & 32 Feet Or Customise



DF-CP-09

100X5/MM



Full Inlay

*Service* is Never Ending  
*Quality*

#### Finishes

Wooden | Anodized | Powder Coating

#### Specification

- 1) System For 12 mm Glass
- 2) Support Glass Height Up to 3 Feet
- 3) Cover Length: 16 Feet & 32 Feet Or Customise



DF-CP-10

120X5/MM



Full Inlay

Customers above *Anything*

**Finishes**

Wooden | Anodized | Powder Coating

**Specification**

- 1) System For 12 mm Glass
- 2) Support Glass Height Up to 3 Feet
- 3) Cover Length: 16 Foot & 32 Foot Or Customise

**DI-CP-11**  
TURKEY

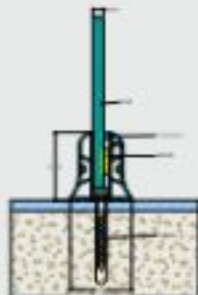

Internal Drainage



Full Drainage



Your happiness is  
what *Matters*

**Finishes**

Wooden | Anodized | Powder Coating

**Specification**

- 1) System For 12 mm Glass
- 2) Support Glass Height Up to 3 Feet
- 3) Cover Length: 16 Foot & 32 Foot Or Customise

**DI-CP-12**  
SOMM TRIANGLE



Internal Drainage



Full Drainage



## Working for customer satisfaction

### Finishes

Wooden | Anodized | Powder Coating

### Specification

- 1) System For 12 mm Glass
- 2) Support Glass Height Up to 3 Feet
- 3) Cover Length: 16 Foot & 32 Foot Or Customise

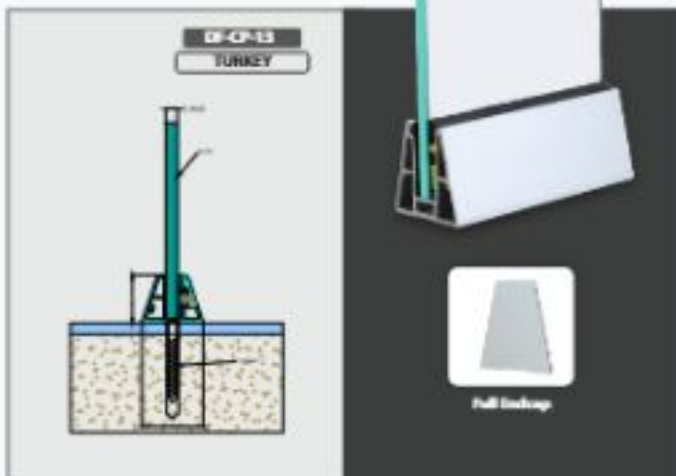

## Dealing with customers Personally

### Finishes

Wooden | Anodized | Powder Coating

### Specification

- 1) System For 12 mm Glass
- 2) Support Glass Height Up to 3 Feet
- 3) Cover Length: 16 Foot & 32 Foot Or Customise

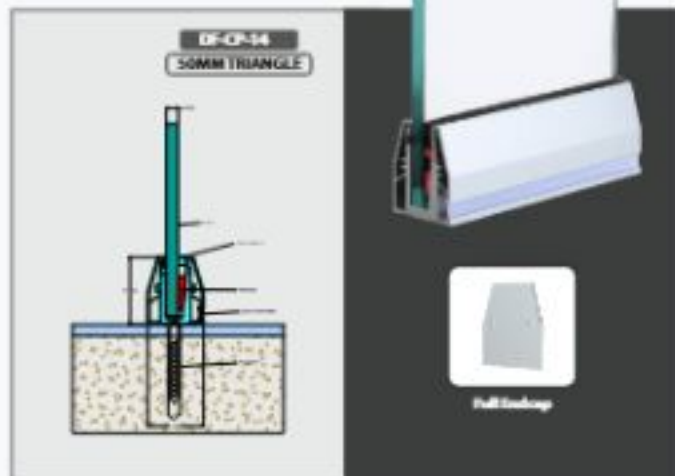

You are our *Priority*

**Finishes**

Wooden | Anodized | Powder Coating

**Specification**

- 1) System For 12 mm Glass
- 2) Support Glass Height Up to 3 to 3.5 Feet
- 3) Cover Length: 16 Feet & 12 Feet Or Customise



**DF-CP-15**

**100X50MM**

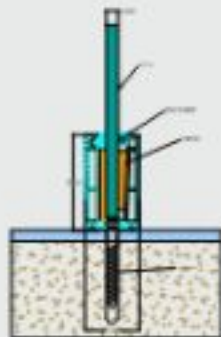

Full Endcap

Quality is a trait that we  
*appreciate.*

**Finishes**

Wooden | Anodized | Powder Coating

**Specification**

- 1) System For 12 mm Glass
- 2) Support Glass Height Up to 3 to 4 Feet
- 3) Cover Length: 12 Feet Or Customise



**DF-CP-16**

**120X50MM**

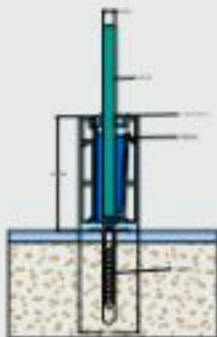

Full Endcap



It is quality rather than *Quantity* that matters. It's not Wrong for products to last long.

**Finishes**

Woodsen | Anodized | Powder Coating

**Specification**

- 1) System For 12 mm to 17.5 mm Glass
- 2) Support Glass Height Up to 4 Feet
- 3) Cover Length: 16 Feet & 32 Feet Or Customize



**DF-CP-17**

125X/6MM

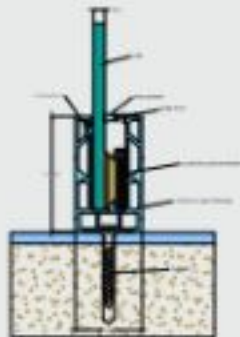

Partial Covering



Full Covering

It's not *Wrong* for products to last long.

**Finishes**

Woodsen | Anodized | Powder Coating

**Specification**

- 1) System For 12 mm to 25 mm Glass
- 2) Support Glass Height Up to 4 Feet
- 3) Cover Length: 12 Feet Or Customize



**DF-CP-18**

100X120MM

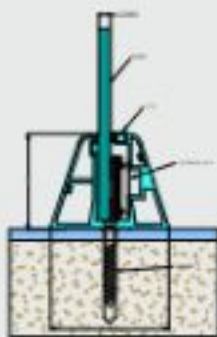

Full Covering

**Concealed  
System**



It is quality rather than *Quantity* that matters.

#### Finishes

Woods | Anodized | Powder Coating

#### Specification

- 1) System For 12 mm Glass
- 2) Support Glass Height Up to 2.5 Feet
- 3) Cover Length: 16 Feet & 32 Feet

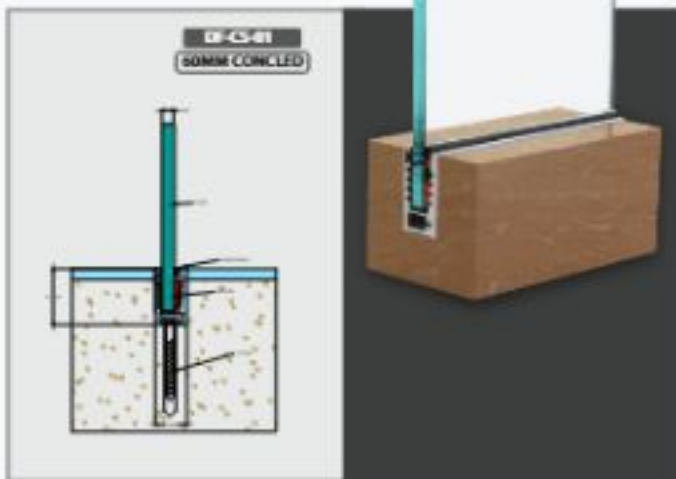

It is *Quality* as opposed to the amount of issues.

#### Finishes

Woods | Anodized | Powder Coating

#### Specification

- 1) System For 12 mm Glass
- 2) Support Glass Height Up to 3 Feet
- 3) Cover Length: 16 Feet & 32 Feet

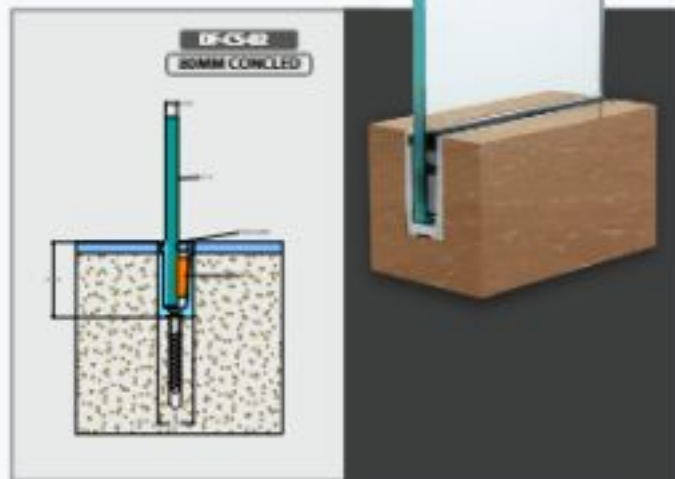

We ~~Define~~ high performance  
and high caliber as well.

#### Finishes

Wooden | Anodized | Powder Coating

#### Specification

- 1) System For 12 mm Glass
- 2) Support Glass Height Up to 3 Feet
- 3) Cover Length: 16 Foot & 32 Foot

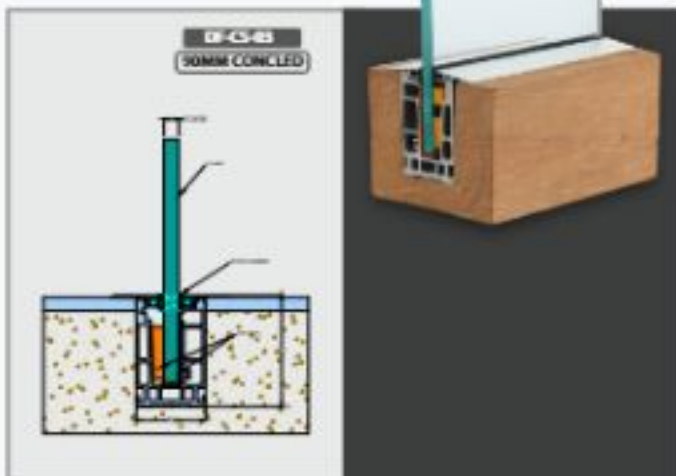

**Side Mount  
System**



It is easier to do a job right  
than to *Explain* why you didn't.

### Finishes

Wooden | Anodized | Powder Coating

### Specification

- 1) System For 1/2 inch Glass
- 2) Support Glass Height Up to 3 Feet
- 3) Cover Length: 16 Foot & 32 Foot

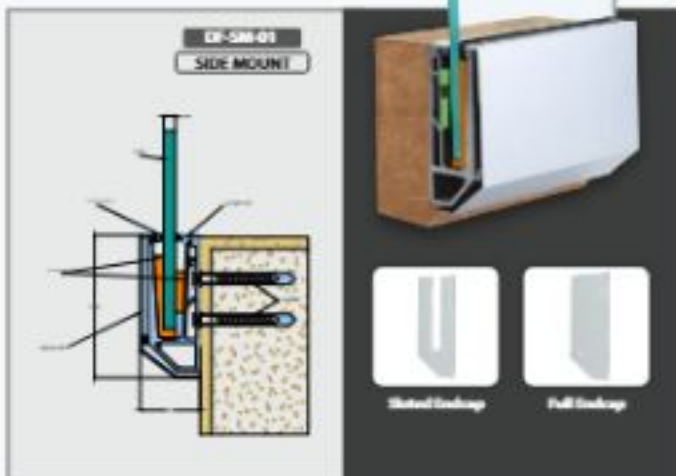

**Bracket  
System**



So, have the best  
*Quality* to be fruitful.

**Finishes**

Wooden | Anodized | Powder Coating

**Specification**

- 1) System For 12 mm Glass
- 2) Support Glass Height Up to 2.5 Feet
- 3) Cover Length: 70 mm



DF-BS-01

L BRACKET

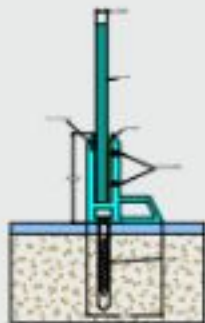

Thus, quality is our *Identity*.

**Finishes**

Wooden | Anodized | Powder Coating

**Specification**

- 1) System For 12 mm Glass
- 2) Support Glass Height Up to 3 Feet
- 3) Cover Length: 70 mm



DF-BS-02

T BRACKET

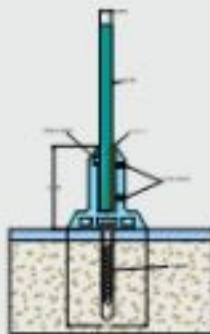



Our *Customers* are the best inspectors indeed.

**Finishes**

Wooden | Anodized | Powder Coating

**Specification**

- 1) System For 12 mm Glass
- 2) Support Glass Height Up to 2.5 Feet
- 3) Cover Length: 70 mm

**DF-85-03**  
**CURVED Y BRACKET**



The cost of *Quality* is certainly very difficult to measure.

**Finishes**

Wooden | Anodized | Powder Coating

**Specification**

- 1) System For 12 mm Glass
- 2) Support Glass Height Up to 3 Feet
- 3) Cover Length: 70 mm

**DF-85-04**  
**Y BRACKET**

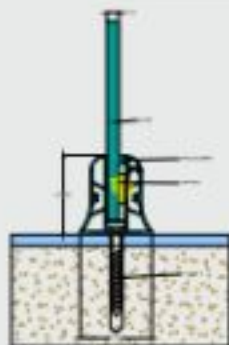

When you are the *Best*  
you need the best too.

**Finishes**

Wooden | Anodized | Powder Coating

**Specification**

- 1) System for 12 mm Glass
- 2) Support Glass Height Up to 2.5 Feet
- 3) Cover Length: 70 mm



DF-85-05

FERRY BRACKET

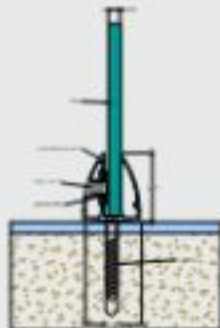

When nothing else  
comes before *Quality*.

**Finishes**

Wooden | Anodized | Powder Coating

**Specification**

- 1) System for 12 mm Glass
- 2) Support Glass Height Up to 3 Feet
- 3) Cover Length: 70 mm



DF-85-06

STEP BRACKET



We *Define* high performance  
and high caliber as well.

**Finishes**

Woods | Anodized | Powder Coating

**Specification**

- 1) System For 12 mm Glass
- 2) Support Glass Height Up to 3 Feet
- 3) Cover Length: 70 mm



**DF-85-07**  
**125MM BRACKET**

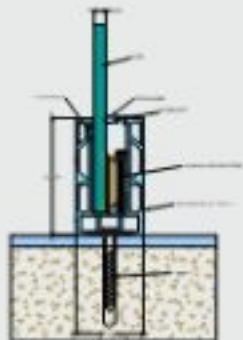

So, have the best  
*Quality* to be fruitful.

**Finishes**

Woods | Anodized | Powder Coating

**Specification**

- 1) System For 12 mm Glass
- 2) Support Glass Height Up to 3 Feet
- 3) Cover Length: 70 mm



**DF-85-06**  
**80MM BRACKET**

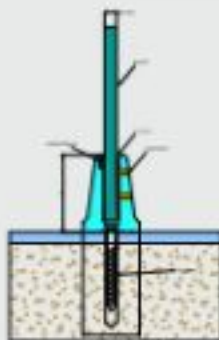

Choose the best and  
leave the rest.

**Finishes**

Wooden | Anodized | Powder Coating

**Specification**

- 1) System For 12 mm Glass
- 2) Support Glass Height Up to 3 Feet
- 3) Cover Length: 55 mm



DF-85-09

VBRACK2

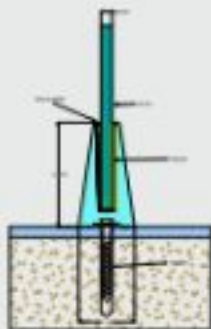

Because we always get  
appreciated for our *Quality*.

**Finishes**

Wooden | Anodized | Powder Coating

**Specification**

- 1) System For 12 mm Glass
- 2) Support Glass Height Up to 3 Feet
- 3) Cover Length: 70 mm



DF-85-10

VBRACK3 6 INCH

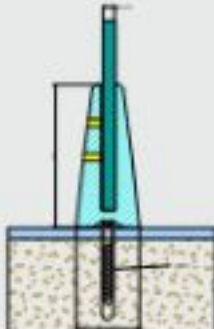

## Top Handrail System



When you deliver the best *Quality*,  
 your business becomes top-notch.



EF-101-SIMM BOUND



ENDCAP



FIX BEND



WALL ENDCAP



MODULAR BEND

Because we always get  
 appreciated for our *Quality*.



EF-102-SIMM BOUND



ENDCAP



FIX BEND



WALL ENDCAP

Because quality is what we get paid for.

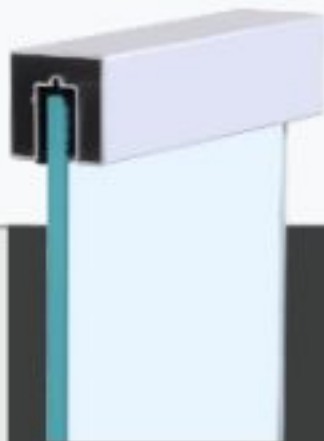
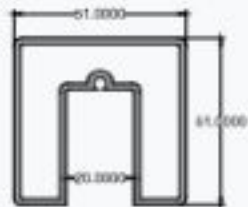

**DF-103-50x50 SQUIRE**



ENDCAP



FIX BEND



WALL CONNECTOR



MODULAR BEND

Put your *Determination* to provide the best in the first place.

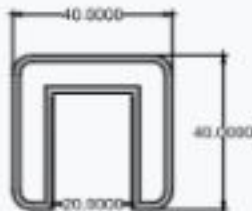

**DF-104-40x40 SQUIRE**



ENDCAP



FIX BEND



WALL CONNECTOR



MODULAR BEND

Pure *Quality* and pure satisfaction above all.

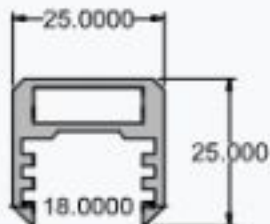

**EF-106-2500 SQMME**



**ENDCAP**



**FIX BEND**



**WALL CONCEAL**

Moreover, show the *Leadership* skills within you.

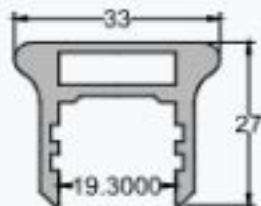

**EF-106-34027**



**ENDCAP**



**FIX BEND**



**WALL CONCEAL**



Quality starts within  
 then works out.



**DF-107 - BIG OVAL**



ENDCAP



FIX BEND



WALL CONCEAL

we know how  
*Prove* your life is

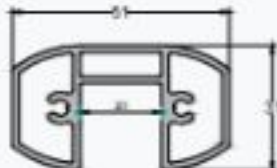

**DF-108 - SMALL OVAL**



ENDCAP



FIX BEND



WALL CONCEAL



MODULAR BEND

*Quality* isn't a demonstration.  
It is a propensity

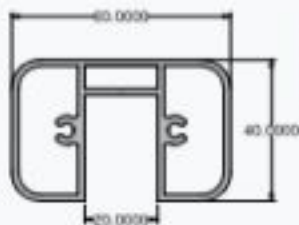

**DF-110-65540 RECTANGLE**



ENDCAP



FIX BEND



WALL CONCEAL



MODULAR BEND

Safety Quality *Perfection*

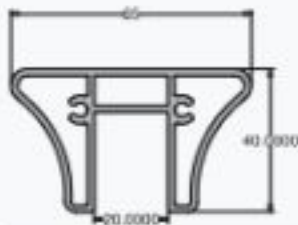

**DF-110-65540 TRIANGLE**



ENDCAP



FIX BEND



WALL CONCEAL



MODULAR BEND

Because quality is *Important*

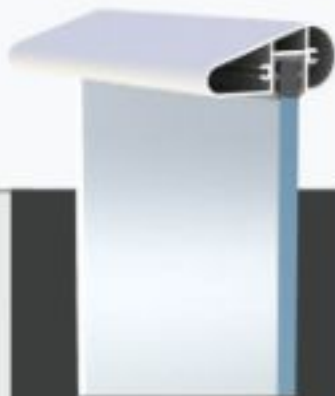
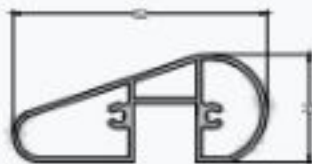

**DF-T11-INCLINE**



ENDCAP



90 DEGREE JOINT



WALL CONCEAL



90 DEGREE JOINT



180 DEGREE JOINT

Quality is the best strategy for *Success*



**DF-T12-LED INCLINE**



ENDCAP



90 DEGREE JOINT



WALL CONCEAL



180 DEGREE JOINT

The quantity has a  
*Quality* all its own.

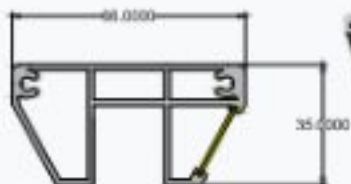

**DF-T13-D-SHAPE LED**



ENDCAP



90 DEGREE  
JOINTER



WALL CONCEAL



180 DEGREE  
JOINTER

*Quality* means doing it right  
when nobody is looking.

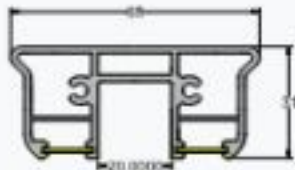

**DF-T14-TWO SIDE LED**



ENDCAP



90 DEGREE  
JOINTER



WALL CONCEAL



180 DEGREE  
JOINTER

Profits are the outcome, the  
*Result* of incredible administration.



**DF-1TS-SLIM HANDRAIL**

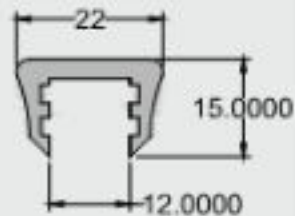

Measure what is quantifiable  
 and *Make* quantifiable what isn't.



**DF-1TS-BRICK RELEASER**

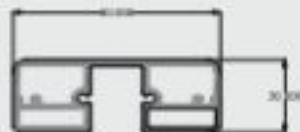

**WALL CONCEAL**



**ENDCAP**

Even However *Quality* Can't Be  
 Characterized, you Realize what  
 Quality is.



DF-117-70x50 RECTANGLE



WALL CONICAL



ENDCAP

o Railing Accessories



316L RAILING ACCESSORIES  
 U.S. 304L



DF-BL-ACC-01A

DF-BL-ACC-01B

DF-BL-ACC-01C

DF-BL-ACC-01D



DF-BL-ACC-01E

DF-BL-ACC-01F

DF-BL-ACC-01G

DF-BL-ACC-01H



DF-BL-ACC-01I

DF-BL-ACC-01J

DF-BL-ACC-01K

DF-BL-ACC-01L

DF-BL-ACC-01M

DF-BL-ACC-01N



DF-BL-ACC-100

DF-BL-ACC-11

DF-BL-ACC-12

DF-BL-ACC-13

DF-BL-ACC-10A

DF-BL-ACC-10B



DF-BL-ACC-101

DF-BL-ACC-102

DF-BL-ACC-103

DF-BL-ACC-104

DF-BL-ACC-11

DF-BL-ACC-12



DF-BL-ACC-13



